

Assembly Instruction

#SH24

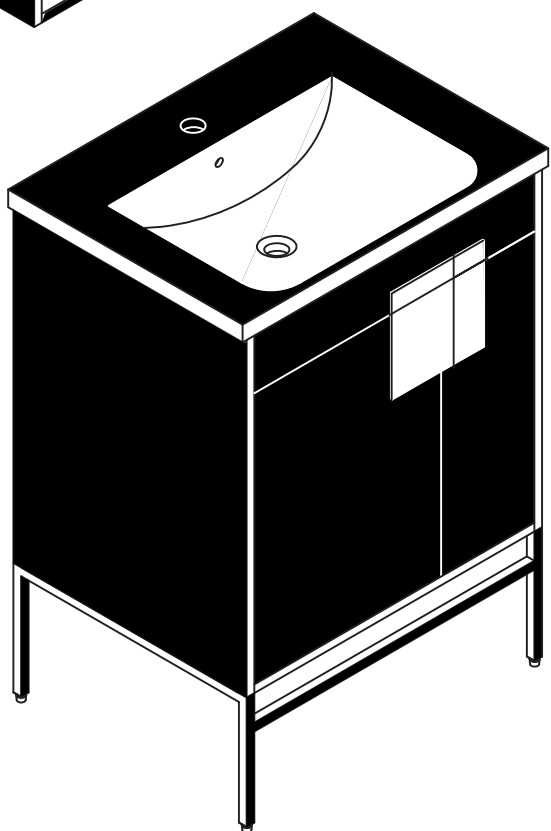

The **shawbridge**
collection

! READ ALL INSTRUCTIONS BEFORE UNPACKING THE PRODUCT

INSTRUCTIONS THAT, IF IGNORED COULD RESULT IN DEATH OR SERIOUS INJURY CAUSED BY INCORRECT HANDLING OR INSTALLATION OF THE PRODUCT. THESE INSTRUCTIONS MUST BE OBSERVED FOR SAFE INSTALLATION.

CAUTION!



**TWO PERSON
LIFT REQUIRED**

**2 PEOPLE ARE REQUIRED TO LIFT AND DURING
ENTIRE INSTALLATION OF THIS PRODUCT**



**INSTALLATION OF THIS PRODUCTS BY AN
INEXPERIENCED INSTALLER MAY RESULT
PERSONAL INJURY OR DEATH!**



We reserves the right to change, update, modify, alter, redesign this manual/product or its policies without prior notice!
It is your responsibility to visit website to download or contact customer service for the most updated version of the installation instructions.

We shall not be liable for any injuries or property damages in connection with this product during installation or use of this product!

Limited warranty is void on any commercial installation.

We are not responsible for local code compliance for this product. Building and plumbing codes may vary from state-to-state in accordance to your location. We are not responsible for providing any compliance certifications.

We are not responsible to provide any type of certifications for this product.





Under no circumstances we are shall not be liable for any and all incidental damages sustained in connection with this product Neither manufacture, nor distributor, nor retailer is responsible for water damage or flood caused due to use of this product.

Under no circumstances We shall not be liable for any and all fees, cost of installation/reinstallation/removal, subsequent damage or transportation in case of the product defect.

VANITY COMPONENTS

During unpacking the product and prior to installation inspect your new product for any damages or missing parts.

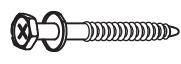
Do not attempt to install or operate the product if the product is damaged.

| | | |
|-------------------|---|---------------------|
| Part A |  4.14mm | 6 Pieces |
| Part B |  | 6 Pieces |
| Part C |  | 6 Pieces |
| Part D |  | 6 Pieces |

TOOLS REQUIRED FOR INSTALLATION

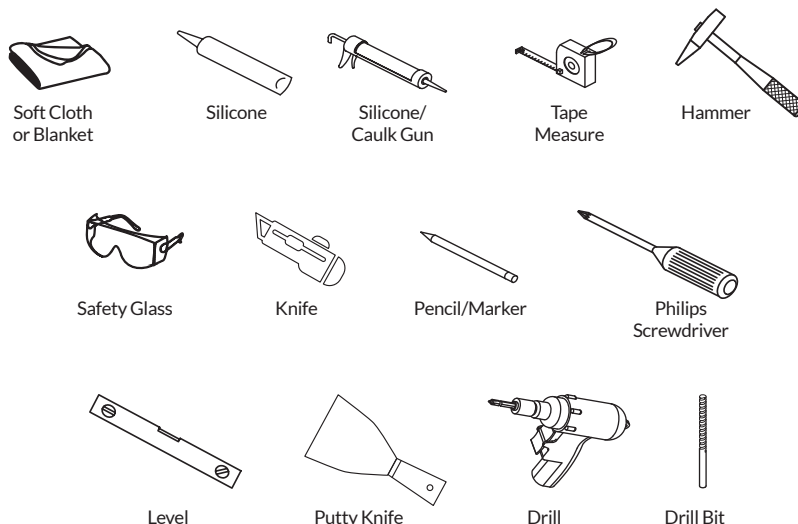

DIMENSIONS/TECHNICAL DATA

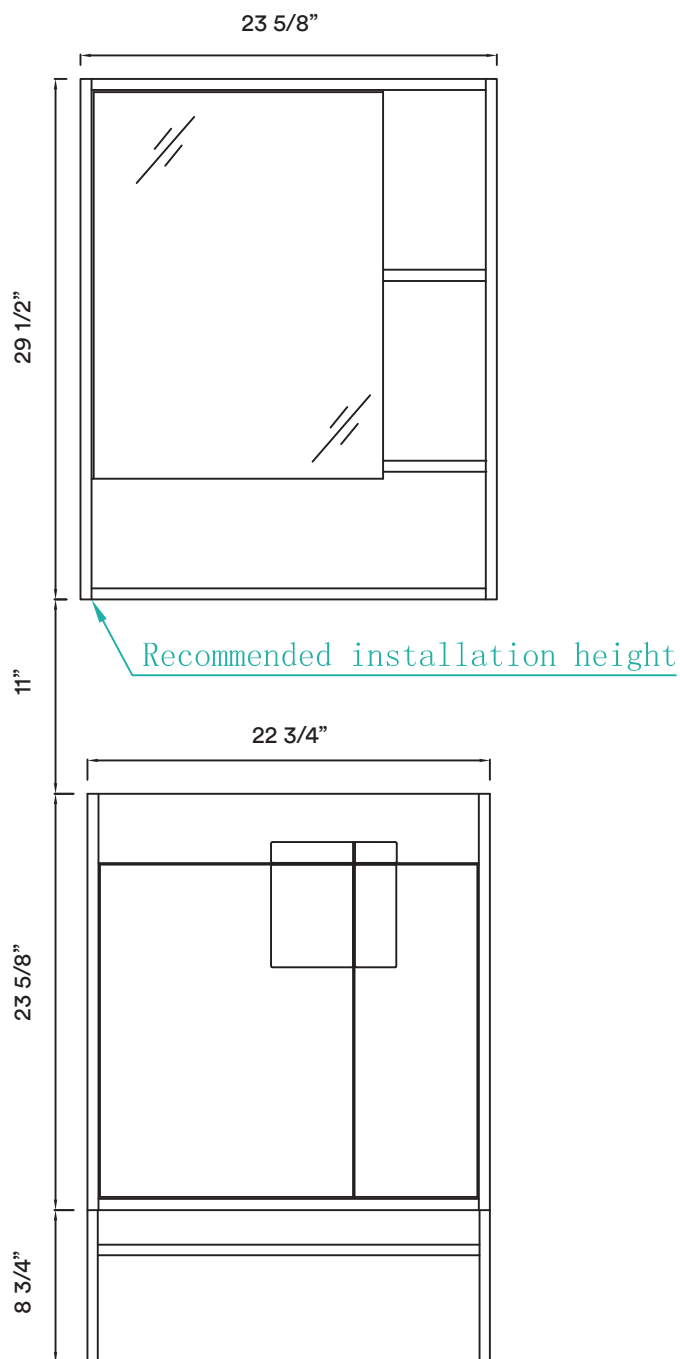

ATTENTION! Dimensions may vary by up to $\frac{3}{8}$ ". It is highly recommended to pull all dimensions of actual model for installation and measuring purposes.

STEP #1

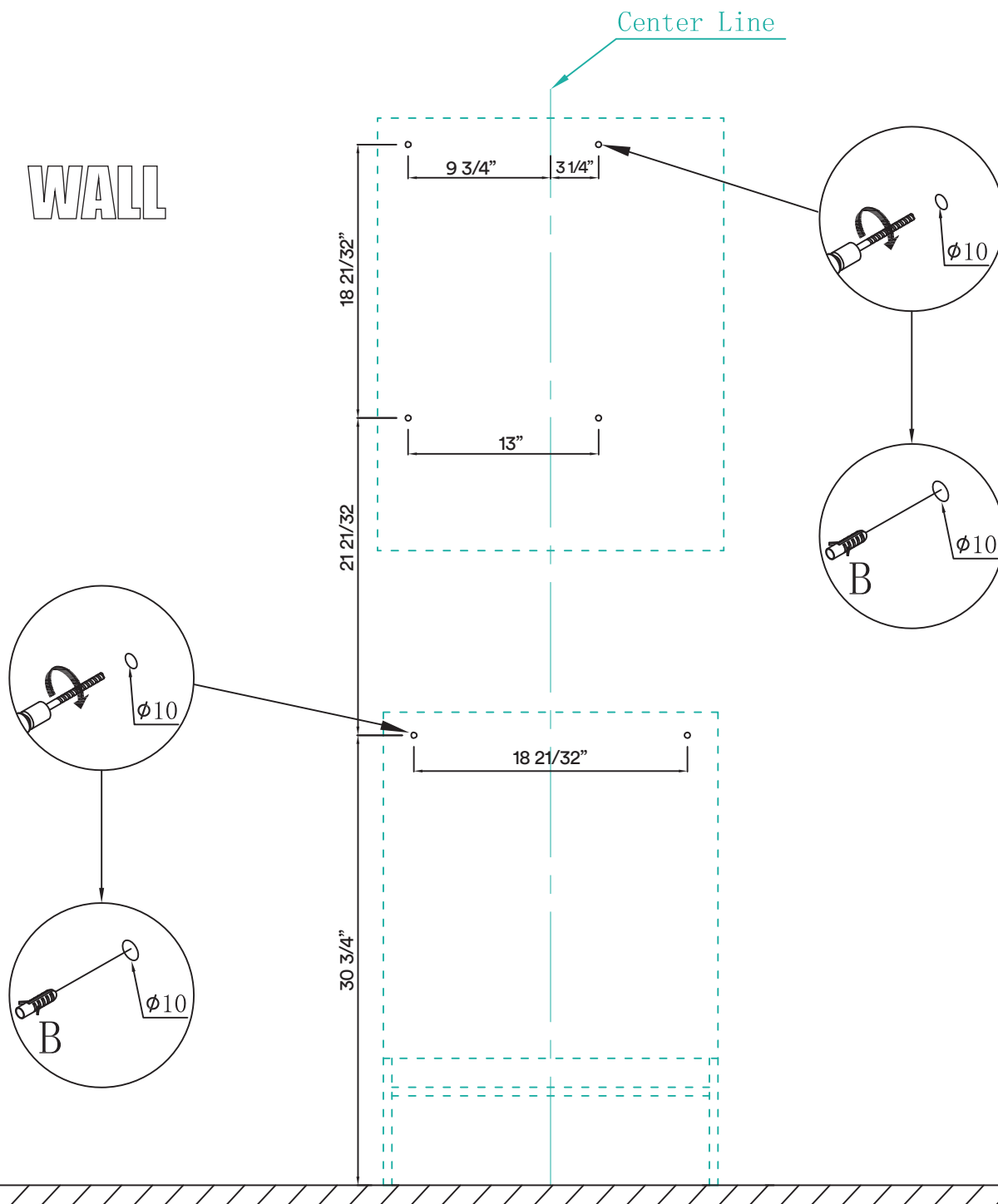

ATTENTION! Dimensions may vary by up to $\frac{3}{8}$ ". It is highly recommended to pull all dimensions of actual model for installation and measuring purposes.

